

Fig. 4a

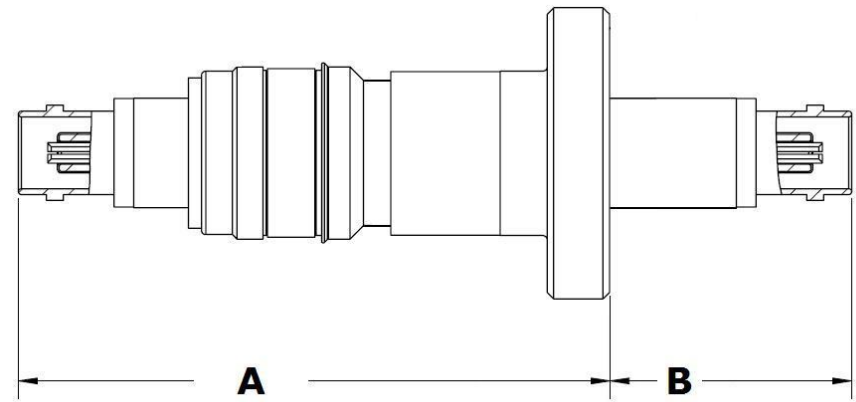

Fig. 4b

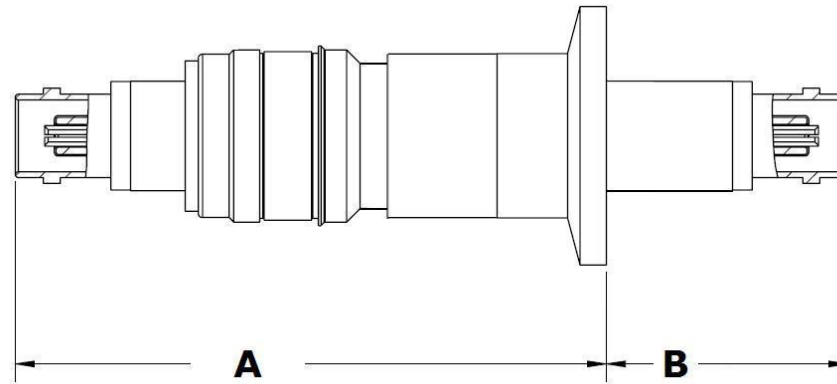

Fig. 4c